

TABLE OF CONTENTS

HEAVY-DUTY APPLICATIONS	PAGE
DIESEL ENGINE	1-2
TRANSMISSION	3-4
DIFFERENTIAL / AXLE	5-6
SUSPENSION	7-8
CAB	9-10
PRODUCT TABLES	11-12

INTRODUCTION

HEAVY-DUTY APPLICATIONS OVERVIEW

At Henkel Corporation, we invent more than just quality products, we provide innovative solutions. When we develop Loctite® branded products, we keep the mechanic in mind. The products must work properly, the first time and every time. Using Loctite® products not only ensures that you are getting the absolute best the aftermarket industry has to offer, but also ensures your profitability by maintaining your fleet and keeping your vehicles on the road longer.

Loctite® products have been reliably solving automotive and truck maintenance and repair needs for over fifty years. We invented the revolutionary method of positively locking and sealing threaded fasteners – Loctite® Threadlocker Adhesives. Henkel Corporation's commitment to excellence has taken thread treatment to a higher level with the recent introduction of the thread treatment and gasketing stick products. We don't provide you with just a product, we provide you with the history, innovation, technology, and customer support that has made the Loctite® brand a leader.

This application guide will show you what Loctite® products you need to perform your heavy-duty fleet repair and maintenance. Additional product sizes and more specific product information can be found in the Automotive Aftermarket products catalog, LT-3770. You can also seek additional support from your local Henkel representative, or by visiting www.loctite.com/aam – a virtual technical library designed to give you the best electronic support in the industry. Log on to obtain additional technical information, such as product material safety data sheets, or to request product samples and application assistance.

For your local Henkel Automotive Aftermarket Sales Representative, call 1-800-434-1836.



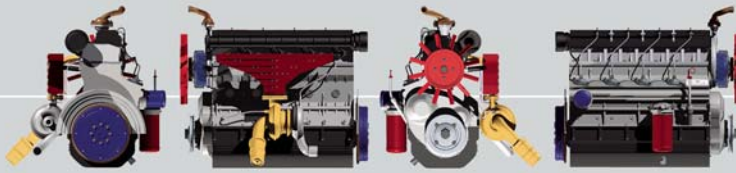

DIESEL ENGINE

Glow Plugs

- Loctite® Copper Anti-Seize Stick

Diesel Injectors

- Loctite® Threadlocker 242®
- Loctite® Gasket Maker 515™

Fuel Line Sealing

- Loctite® PST® Thread Sealant 565™
- Loctite® PST® Thread Sealant Stick

Cylinder Head Bolts

- Loctite® Threadlocker 262™

Oil Filter Mounting Block O-Rings

- Loctite® Dielectric Tune-Up Grease

Accessory Mounting Bolts

- Loctite® Blue Threadlocker Stick
- Loctite® Threadlocker 242®

Oil Pan Gasket

- Loctite® Hi-Tack Stick
- Loctite® Ready Gasket
- Loctite® Gasket Maker 515™

Fuel Filter Mounting

- Loctite® Dielectric Tune-Up Grease
- Loctite® PST® Thread Sealant Stick

Dipstick Sleeve

- Loctite® Bearing Mount 660™/680™

Connecting Rod Cap Bolts

- Loctite® Threadlocker 271™
- Loctite® Red Threadlocker Stick

Crankshaft Sleeve Seal

- Loctite® Gasket Maker 515™

Threaded Water Pump Fittings

- Loctite® PST® Thread Sealant 565™
- Loctite® PST® Thread Sealant Stick

Water Pump Gasket

- Loctite® RTV 5920™ Copper Silicone Gasket Maker

Water Pump Mounting Hardware Pulley Bolts

- Loctite® Threadlocker 242®
- Loctite® Blue Threadlocker Stick

DIESEL ENGINE

HEAVY-DUTY DIESEL APPLICATIONS



Intake Manifold Gasket

- Loctite® Ready Gasket
- Loctite® Threadlocker 242®
- Loctite® Blue Threadlocker Stick

Intake Manifold Bolts

- Loctite® Threadlocker 242™
- Loctite® Blue Threadlocker Stick

Exhaust Gaskets

- Loctite® RTV 5920™ Copper Silicone Gasket Maker

Thermostat Housing

- Loctite® Ready Gasket
- Loctite® Gasket Maker 515™

Exhaust Manifold Studs

- Loctite® Copper Anti-Seize Stick

Heat Shield Hardware

- Loctite® Copper Anti-Seize Stick

Turbo Mounting Flange

- Loctite® Copper Anti-Seize Stick

Threaded Core Plugs

- Loctite® PST® Thread Sealant 565™
- Loctite® PST® Thread Sealant Stick

Flywheel Bolts

- Loctite® Red Threadlocker Stick
- Loctite® Threadlocker 262™

Oil / Water Cooling Lines

- Loctite® PST® Thread Sealant 565™
- Loctite® PST® Thread Sealant Stick



for additional product information,
log on to www.loctite.com/aam

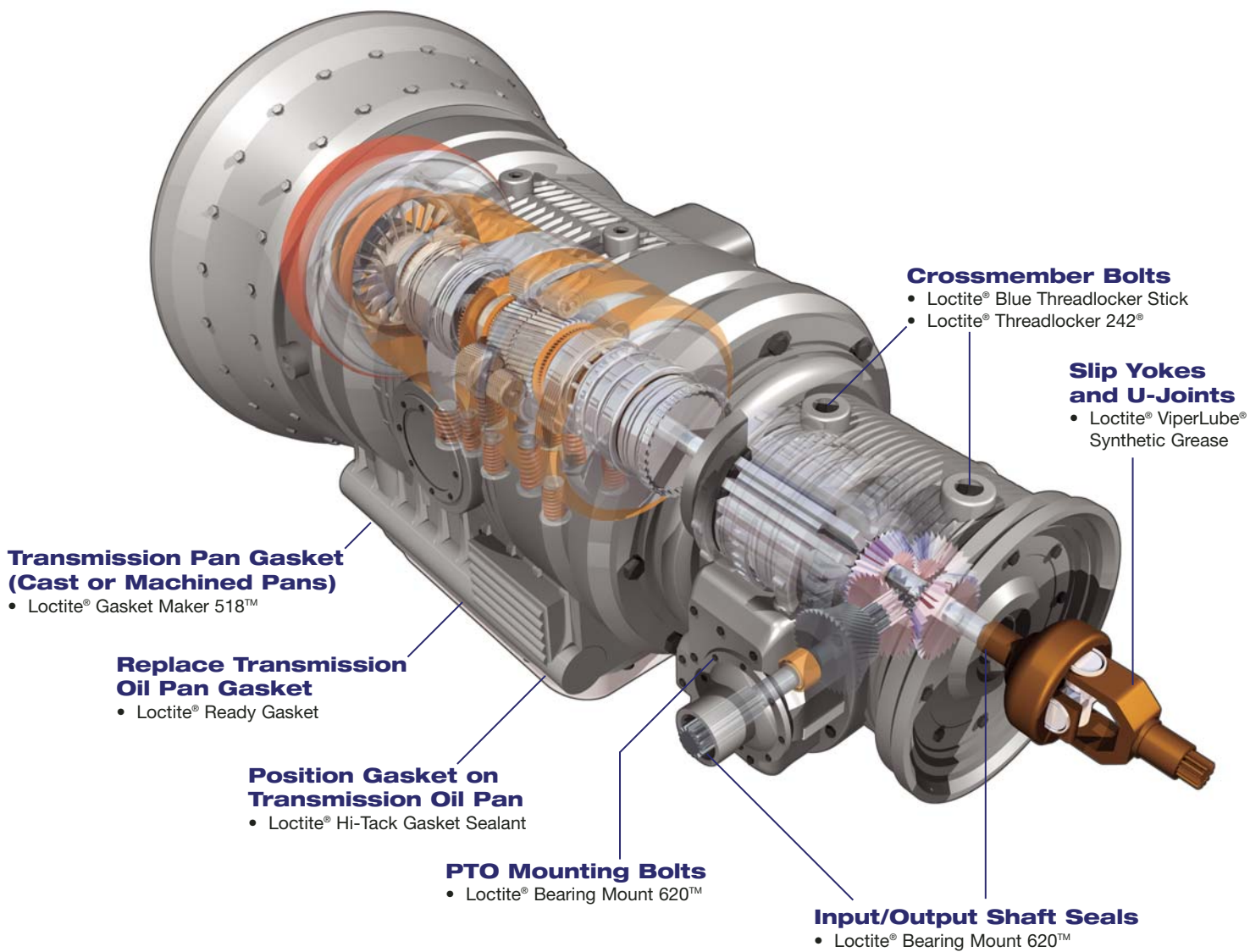
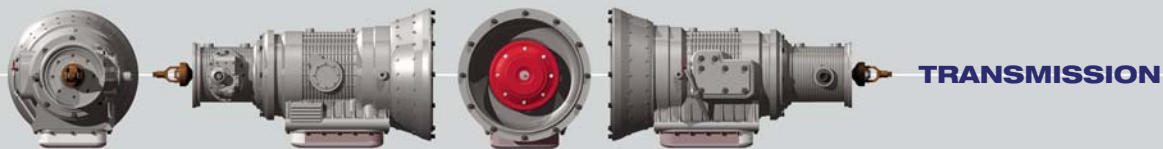

TRANSMISSION

HEAVY-DUTY TRANSMISSION APPLICATIONS



Plastic Electrical Plugs

- Loctite® Dielectric Tune-Up Grease

Housing Bolts

- Loctite® Blue Threadlocker Stick
- Loctite® Threadlocker 242®

Case Assembly Bolts

- Loctite® Blue Threadlocker Stick
- Loctite® Threadlocker 242®

Torque Converter Bolts

- Loctite® Threadlocker 271™
- Loctite® Red Threadlocker Stick

Flywheel to Torque Converter

- Loctite® Threadlocker 262™

Oil Dipstick Tube

- Loctite® Bearing Mount 680™

Transmission Pan Bolts

- Loctite® Blue Threadlocker Stick
- Loctite® Threadlocker 242®

Case Dowel Pins

- Loctite® Bearing Mount 609™

Torque Converter Seal

- Loctite® Bearing Mount 620™

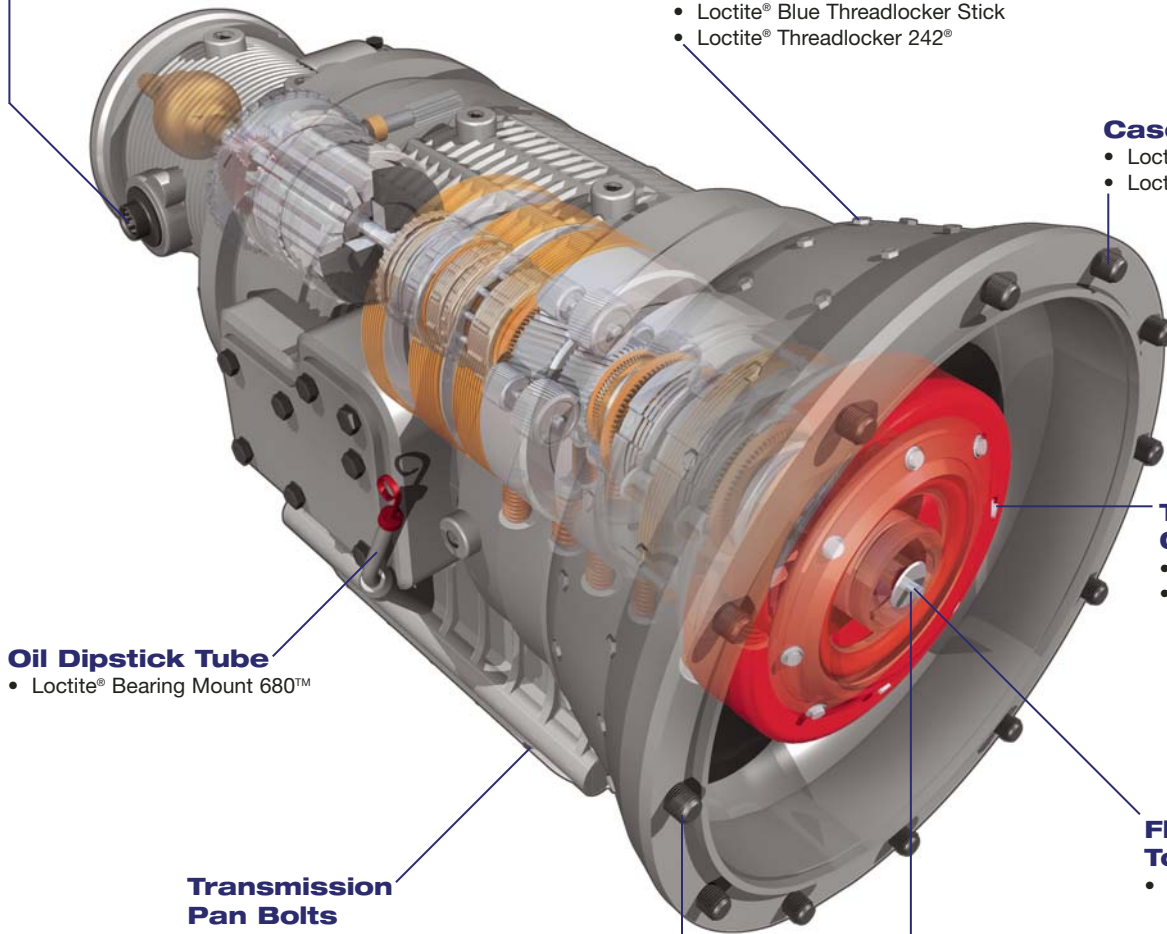



DIFFERENTIAL

Pneumatic Brake Lines

- Loctite® PST® Thread Sealant 565™
- Loctite® PST® Thread Sealant Stick

Differential Cover Mounting Bolts

- Loctite® Blue Threadlocker Stick

Differential Cover Gasket

- Loctite® Ready Gasket

Ring Gear

- Loctite® Threadlocker 262™
- Loctite® Gasket Maker 518™

Suspension Bushings

- Loctite® ViperLube® Synthetic Grease

Drum Brakes - Adjustment Hardware, Brake Shoe Slides

- Loctite® Silver Anti-Seize Stick



for additional product information,
log on to www.loctite.com/aam

DIFFERENTIAL / AXLE

HEAVY-DUTY DIFFERENTIAL / AXLE APPLICATIONS

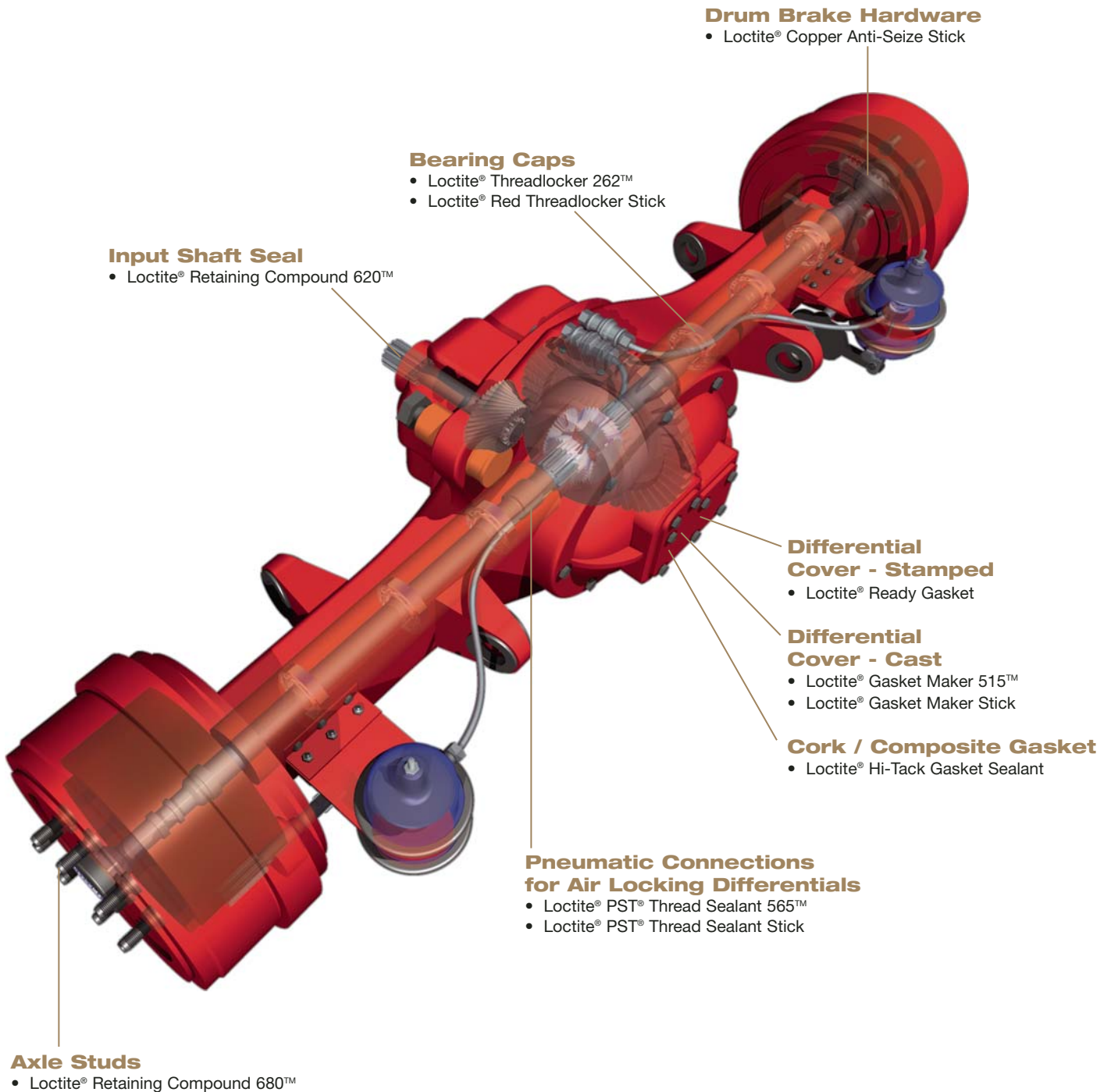

Drum Brake Hardware

- Loctite® Copper Anti-Seize Stick

Bearing Caps

- Loctite® Threadlocker 262™
- Loctite® Red Threadlocker Stick

Input Shaft Seal

- Loctite® Retaining Compound 620™

Differential Cover - Stamped

- Loctite® Ready Gasket

Differential Cover - Cast

- Loctite® Gasket Maker 515™
- Loctite® Gasket Maker Stick

Cork / Composite Gasket

- Loctite® Hi-Tack Gasket Sealant

Pneumatic Connections for Air Locking Differentials

- Loctite® PST® Thread Sealant 565™
- Loctite® PST® Thread Sealant Stick

Axle Studs

- Loctite® Retaining Compound 680™

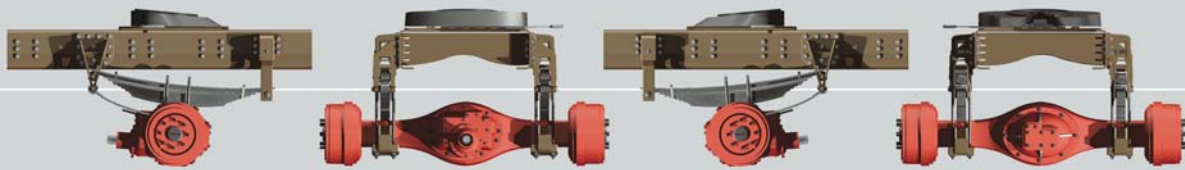

SUSPENSION

Chassis Crossmember Bolts

- Loctite® Red Threadlocker Stick

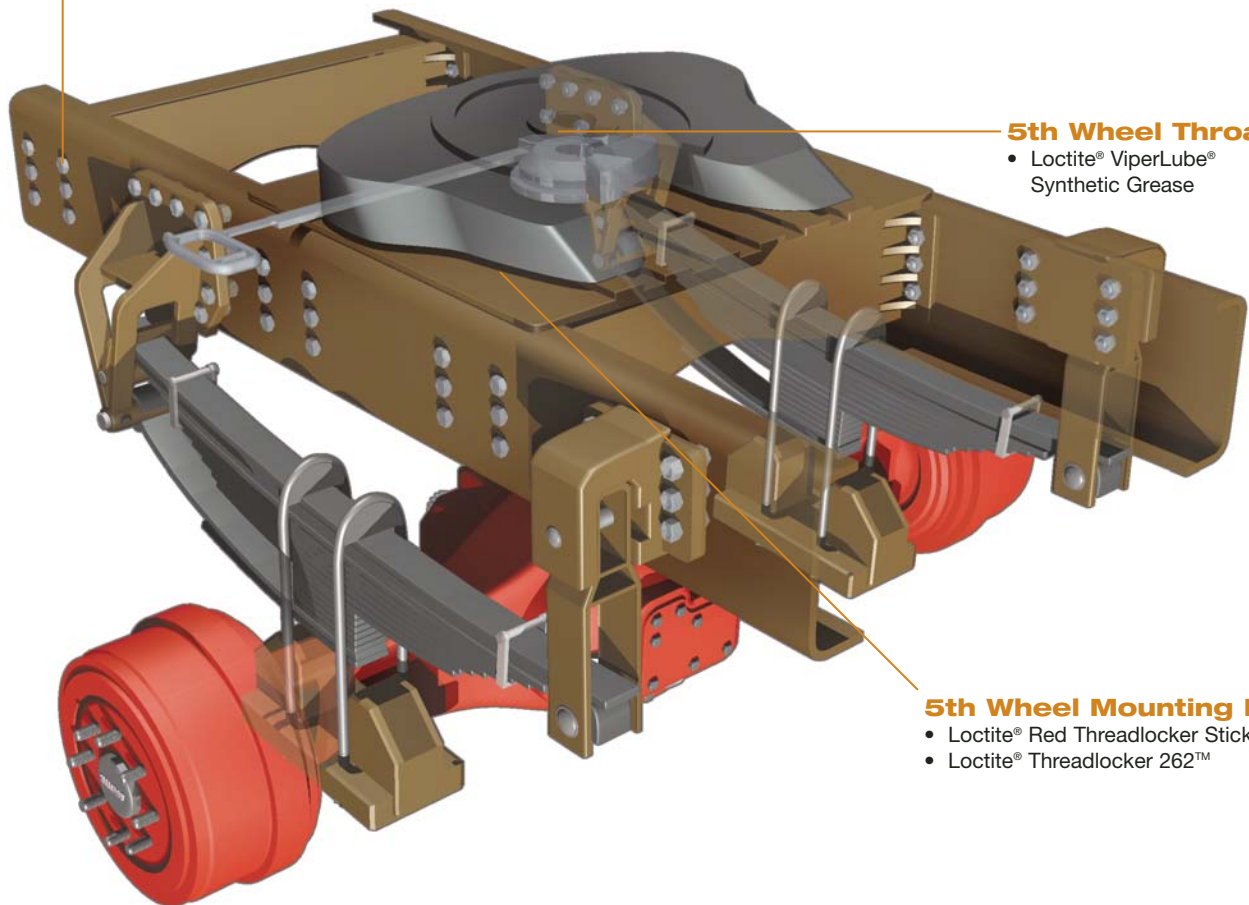

5th Wheel Throat

- Loctite® ViperLube® Synthetic Grease

5th Wheel Mounting Bolts

- Loctite® Red Threadlocker Stick
- Loctite® Threadlocker 262™

SUSPENSION

HEAVY-DUTY SUSPENSION APPLICATIONS

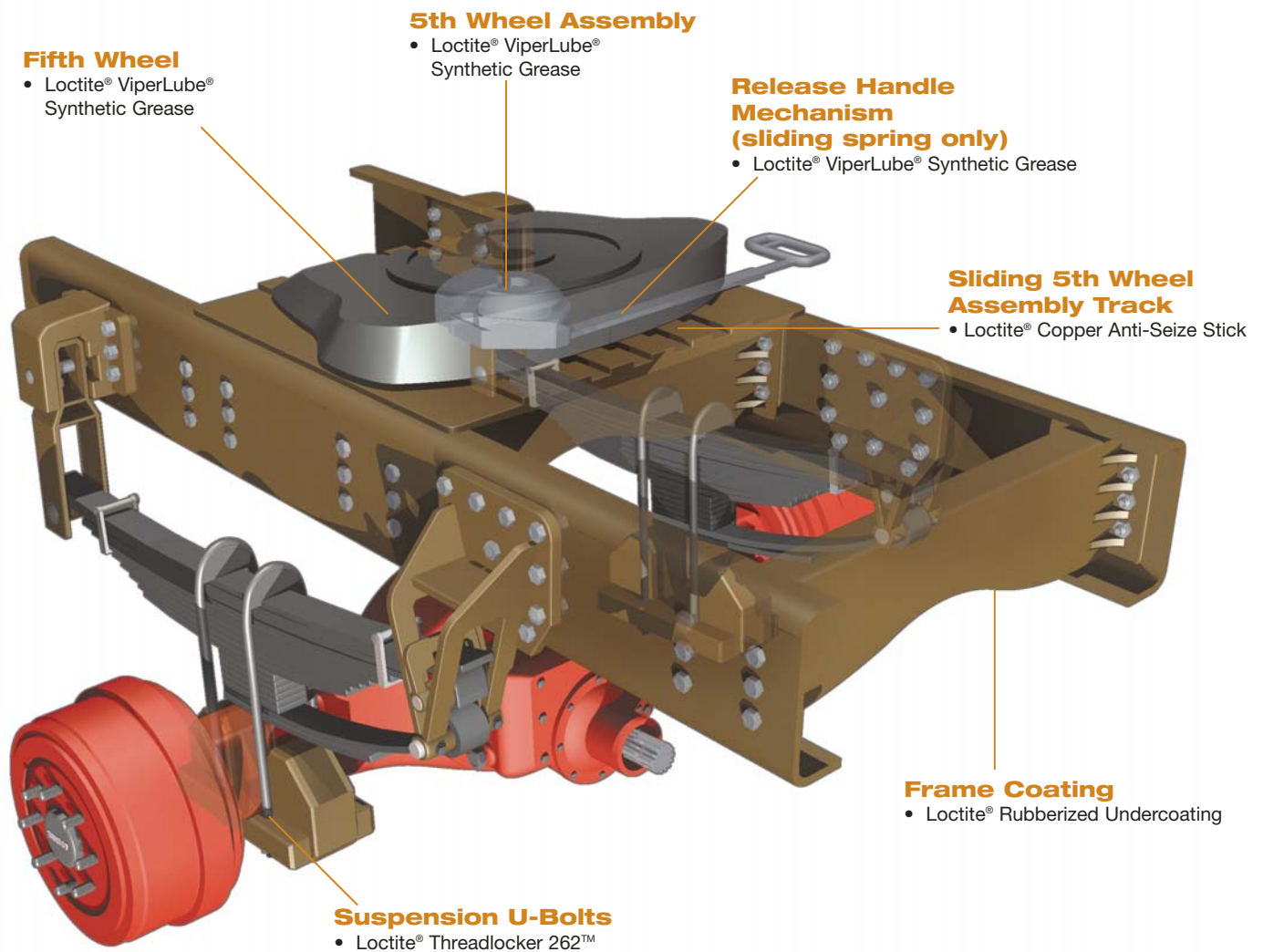

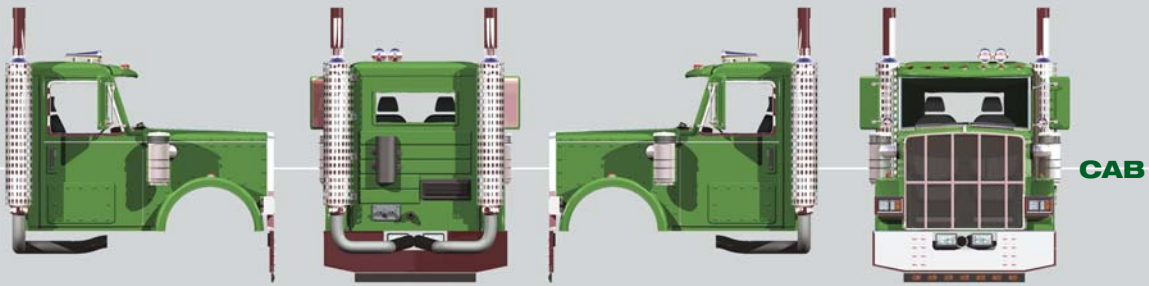

Exhaust Stack Hardware

- Loctite® Threadlocker 242®

Running Light Fasteners

- Loctite® Threadlocker 242®

Mirror Mounting Hardware

- Loctite® Threadlocker 242®

Air Hose Connection

- Loctite® PST® Thread Sealant 565™
- Loctite® PST® Thread Sealant Stick

Electrical Connector

- Loctite® Dielectric Tune-Up Grease

Door Weatherstrip

- Loctite® Black Contact Adhesive

Door Hinge Hardware

- Loctite® Threadlocker 242®
- Loctite® ViperLube® Synthetic Grease

Door Seal Conditioning

- Loctite® Silicone Lubricant

CAB

HEAVY-DUTY CAB APPLICATIONS

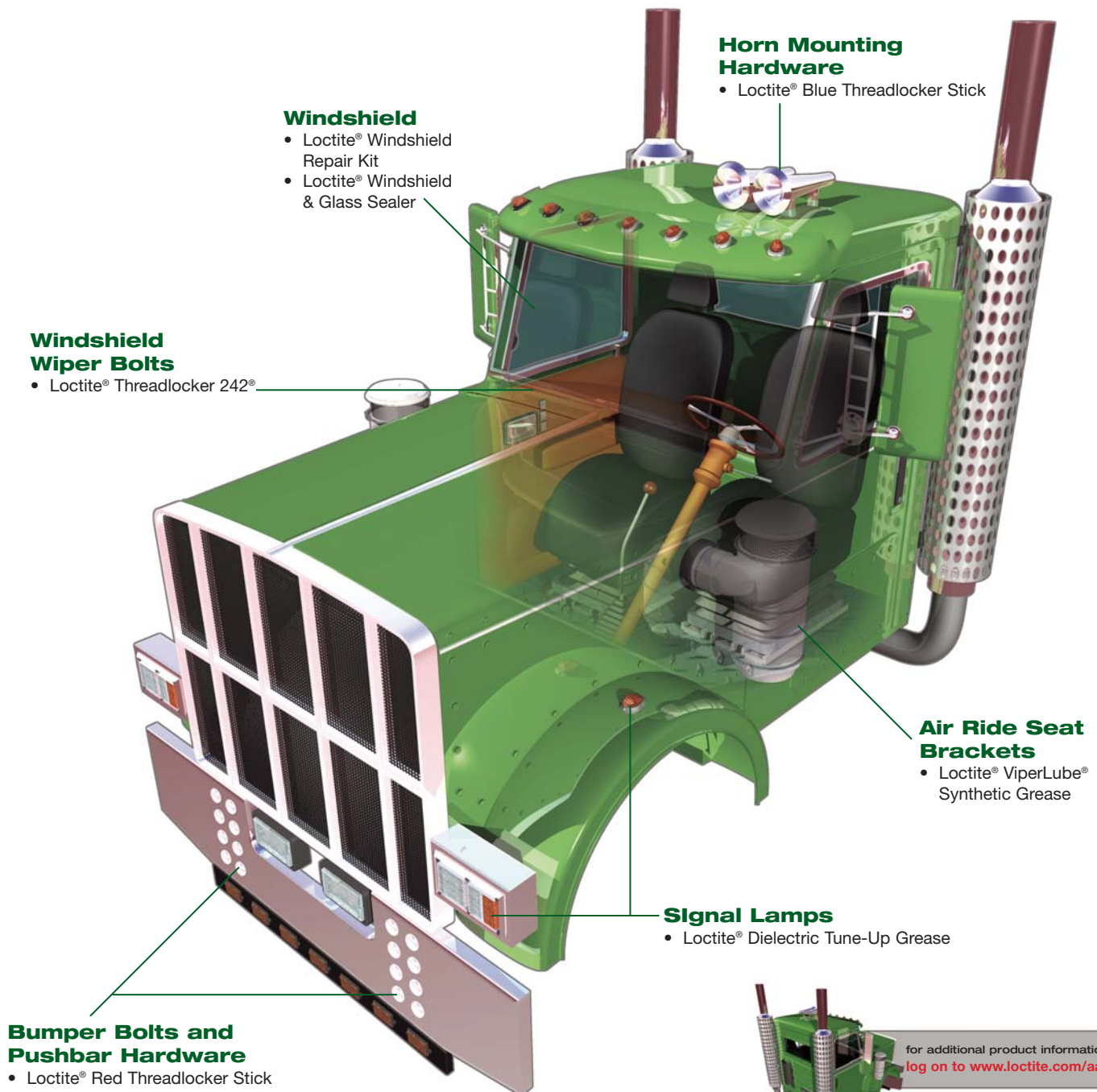

for additional product information,
log on to www.loctite.com/aam



PRODUCTS





PICTURE	P/N	PRODUCT NAME	SIZE	PACK
ADHESIVES				
	37532	Loctite® Black Weatherstrip Adhesive	5 oz. tube	12
	37471	Loctite® Windshield & Glass Sealer – Flowable Silicone	1.35 fl. oz. tube	12
	37613	Loctite® Windshield Repair Kit	0.17 fl. oz. syringe	12
BEARING MOUNTS				
	38652	Loctite® Bearing Mount 620™ – High Temperature	36 ml tube	12
	37483	Loctite® Bearing Mount 609™ – General Purpose/Close Fits	36 ml bottle	6
	37485	Loctite® Bearing Mount 680™ – High Strength/Relaxed Fits	36 ml bottle	6
	39150	Loctite® Bearing Mount Stick	9 g stick	10
	38651	Loctite® Press Fit Repair 660™ for Worn Parts	50 ml tube	6

PICTURE	P/N	PRODUCT NAME	SIZE	PACK
GASKETING				
	38655	Loctite® Gasket Maker 515™	50 ml tube	6
	37394	Loctite® Gasket Maker 518™	50 ml tube	6
	39154	Loctite® Gasket Maker Stick	9 g stick	10
	37553	Loctite® Hi-Tack Gasket Sealant	16 fl. oz. brushtop	12
	39158	Loctite® Hi-Tack Stick	19 g stick	6
	37510	Loctite® Ready Gasket – Gasket Maker	7 oz. can	6
	37466	Loctite® RTV 5920™ High Performance Copper Silicone Gasket Maker	80 ml tube	12

PRODUCT TABLES

HEAVY-DUTY PRODUCT CHARTS



PICTURE	P/N	PRODUCT NAME	SIZE	PACK
LUBRICANTS				
	37562	Loctite® Copper Anti-Seize Lubricant	1 lb. brushtop	12
	37616	Loctite® Copper Anti-Seize Stick	20 g stick	6
	37535	Loctite® Dielectric Tune-Up Grease	3 oz. tube	6
	37580	Loctite® Rubberized Undercoating	16 oz. aerosol	12
	37584	Loctite® Silicone Lubricant	13 oz. aerosol	12
	37617	Loctite® Silver Anti-Seize Stick	20 g stick	6
	37577	Loctite® ViperLube® High Performance Synthetic Grease	400 g cartridge	12

PICTURE	P/N	PRODUCT NAME	SIZE	PACK
THREAD TREATMENTS				
	37614	Loctite® Blue Threadlocker Stick – Medium Strength	19 g stick	6
	37396	Loctite® PST® Thread Sealant 565™	50 ml tube	6
	37615	Loctite® PST® Thread Sealant Stick	19 g stick	6
	37700	Loctite® Red Threadlocker Stick – High Strength	19 g stick	6
	37477	Loctite® Threadlocker 242® – Medium Strength/Blue	36 ml bottle	6
	37478	Loctite® Threadlocker 262™ – High Strength/Red	36 ml bottle	6
	37479	Loctite® Threadlocker 271™ – Heavy Duty/Red	36 ml bottle	6



Henkel – Your partner worldwide

The Automotive Aftermarket Group of Henkel

Henkel Corporation
1001 Trout Brook Crossing
Rocky Hill, Connecticut 06067
Phone: 860.571.5100
Fax: 860.571.5465
Customer Service: 1.800.434.1836
www.loctite.com/aam



HEAVY-DUTY FLEET APPLICATIONS FOR REPAIR AND MAINTENANCE

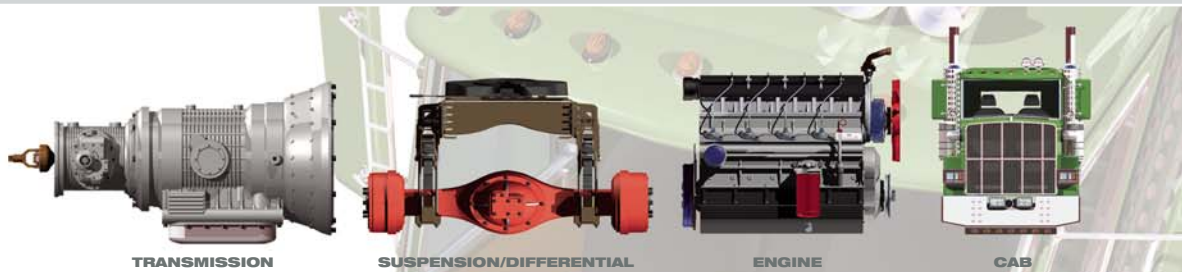

TRANSMISSION

SUSPENSION/DIFFERENTIAL

ENGINE

CAB

